

PRODUKTKATALOG

MARINESTIGER & TILBEHØR

GITTERBAKKER & TILBEHØR

KABELBAKKER & TILBEHØR



 **SCANKAB** Systems
Cable Management Systems



INDHOLDSFORTEGNELSE

Dette produktkatalog indeholder tekniske informationer om vores brede sortiment af marinestiger.

Søger du informationer om gitterbakker og kabelbakker samt dertilhørende tilbehør, da henviser vi til vores øvrige produktkataloger eller vores samlede produktkatalog.

Kontakt os for nærmere information på +45 6343 1545 eller se mere på www.scankabsystems.dk.

MARINESTIGER	4
4x40	
3x37	
3x30	
5x30	
Samlingsplade	
<hr/>	
HORISONTALE BØJNINGER	6
H: 40	
H: 37	
H: 30	
<hr/>	
HORISONTALE VINKELBESLAG	7
H: 40	
H: 37	
H: 30	
<hr/>	
VERTIKALE BØJNINGER	8
H: 40	
H: 37	
H: 30	
<hr/>	
T- & KRYDSSTYKKER	9
H: 40	
H: 37	
H: 30	
<hr/>	
TILBEHØR	10
Vægbeslag	
<hr/>	

Marinestige (H: 40 mm, L: 3000 mm)
Materialetykkelse: 4 mm



4x40



Fire resistans test
1049°C, 120 min.

Vare-nr. (HDG)	Vare-nr. (SS316)	Bredde (mm)
AGS-10	AGS-10-316	100
AGS-15	AGS-15-316	150
AGS-20	AGS-20-316	200
AGS-25	AGS-25-316	250
AGS-30	AGS-30-316	300
AGS-35	AGS-35-316	350
AGS-40	AGS 40-316	400
AGS-45	AGS 45-316	450
AGS-50	AGS 50-316	500
AGS-55	AGS 55-316	550
AGS-60	AGS 60-316	600
AGS-65	AGS 65-316	650
AGS-70	AGS 70-316	700
AGS-75	AGS 75-316	750

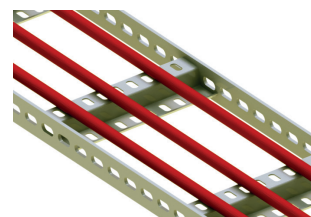

Koblingsbeslag, lige

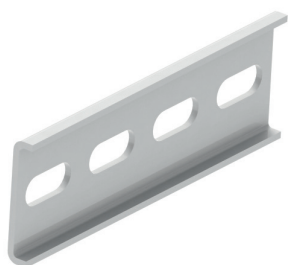

Vare-nr. (HDG)	Vare-nr. (SS316)	H (mm)	L (mm)
AGS-1	AGS-1-316	41	140

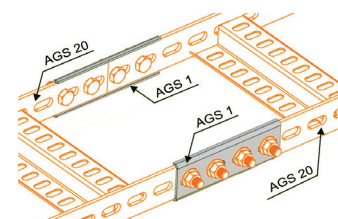

Marinestige (H: 37 mm, L: 3000 mm)
Materialetykkelse: 3 mm

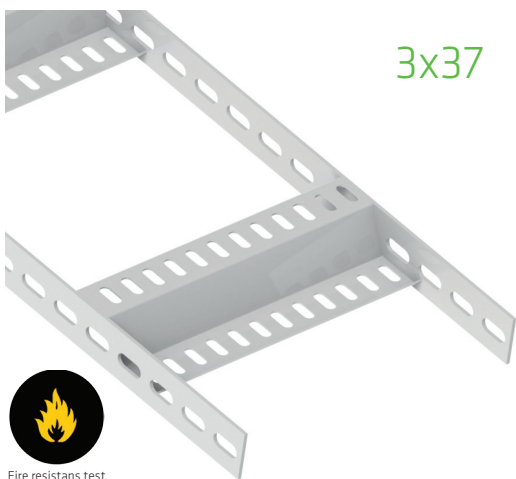

3x37



Fire resistans test
1049°C, 120 min.

Vare-nr. (HDG)	Vare-nr. (SS316)	Bredde (mm)
AGZ-10	AGZ-10-316	100
AGZ-15	AGZ-15-316	150
AGZ-20	AGZ-20-316	200
AGZ-25	AGZ-25-316	250
AGZ-30	AGZ-30-316	300
AGZ-35	AGZ-35-316	350
AGZ-40	AGZ-40-316	400
AGZ-45	AGZ-45-316	450
AGZ-50	AGZ-50-316	500
AGZ-55	AGZ-55-316	550
AGZ-60	AGZ-60-316	600
AGZ-65	AGZ-65-316	650
AGZ-70	AGZ-70-316	700
AGZ-75	AGZ-75-316	750

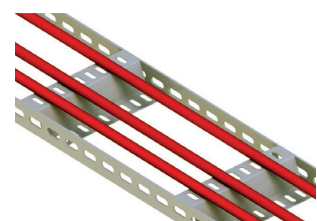

Koblingsbeslag, lige

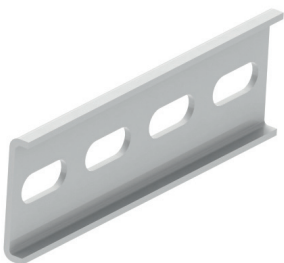

Vare-nr. (HDG)	Vare-nr. (SS316)	H (mm)	L (mm)
AGZ-1	AGZ-1-316	38	140

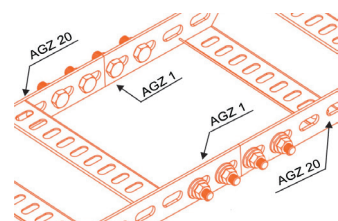

Marinestige (H: 30 mm, L: 3000 mm)
Materialetykkelse: 3 mm

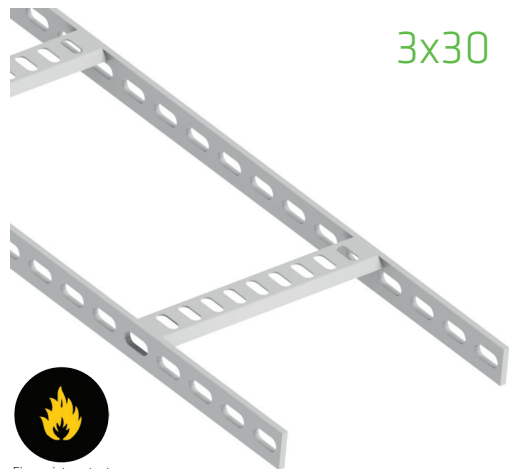

3x30



Fire resistans test
1049°C, 120 min.

Vare-nr. (HDG)	Vare-nr. (SS316)	Bredde (mm)
AGV-103	AGV-103-316	100
AGV-153	AGV-153-316	150
AGV-203	AGV-203-316	200
AGV-253	AGV-253-316	250
AGV-303	AGV-303-316	300
AGV-353	AGV-353-316	350
AGV-403	AGV-403-316	400
AGV-453	AGV-453-316	450
AGV-503	AGV-503-316	500
AGV-553	AGV-553-316	550
AGV-603	AGV-603-316	600

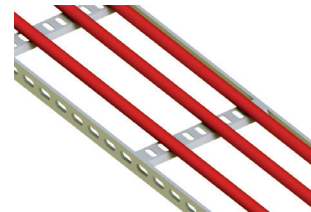

Koblingsbeslag, lige

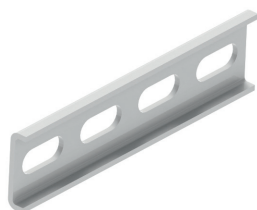

Vare-nr. (HDG)	Vare-nr. (SS316)	H (mm)	L (mm)
AGV-1	AGV-1-316	30	140

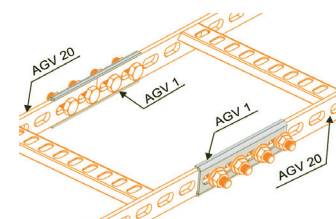

Marinestige (H: 30 mm, L: 3000 mm)
Materialetykkelse: 5 mm



5x30



Fire resistans test
1049°C, 120 min.

Vare-nr. (HDG)	Vare-nr. (SS316)	Bredde (mm)
AGV-105	AGV-105-316	100
AGV-155	AGV-155-316	150
AGV-205	AGV-205-316	200
AGV-255	AGV-255-316	250
AGV-305	AGV-305-316	300
AGV-355	AGV-355-316	350
AGV-405	AGV-405-316	400
AGV-455	AGV-455-316	450
AGV-505	AGV-505-316	500
AGV-555	AGV-555-316	550
AGV-605	AGV-605-316	600

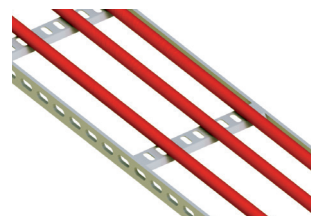

Koblingsbeslag, lige

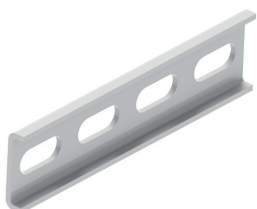

Vare-nr. (HDG)	Vare-nr. (SS316)	H (mm)	L (mm)
AGV-1	AGV-1-316	30	140

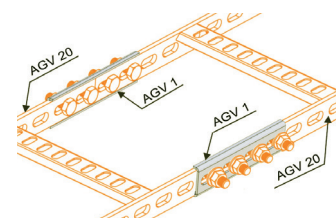

90° bøjning (H: 40 mm)

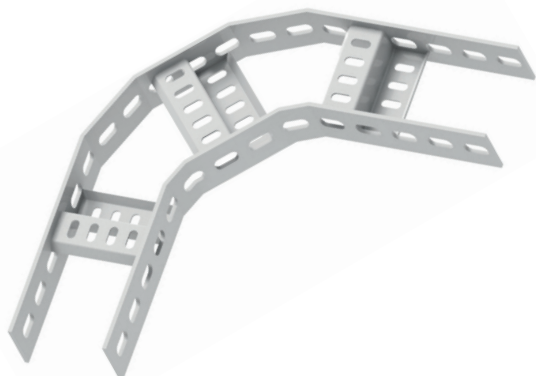

Vare-nr. (HDG)	Vare-nr. (SS316)	Bredde (mm)
AGS-10-D	AGS-10-D-316	100
AGS-15-D	AGS-15-D-316	150
AGS-20-D	AGS-20-D-316	200
AGS-25-D	AGS-25-D-316	250
AGS-30-D	AGS-30-D-316	300
AGS-35-D	AGS-35-D-316	350
AGS-40-D	AGS-40-D-316	400
AGS-45-D	AGS-45-D-316	450
AGS-50-D	AGS-50-D-316	500
AGS-55-D	AGS-55-D-316	550
AGS-60-D	AGS-60-D-316	600
AGS-65-D	AGS-65-D-316	650
AGS-70-D	AGS-70-D-316	700
AGS-75-D	AGS-75-D-316	750

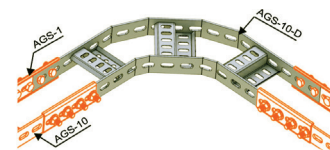

90° bøjning (H: 37 mm)

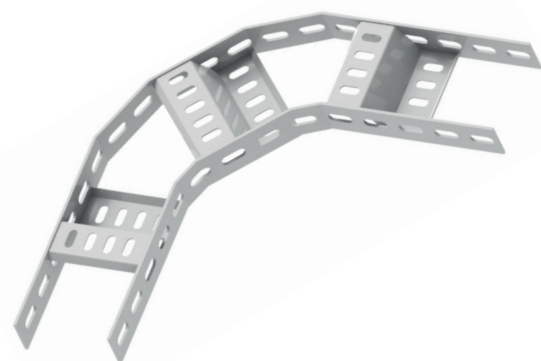

Vare-nr. (HDG)	Vare-nr. (SS316)	Bredde (mm)
AGZ-10-D	AGZ-10-D-316	100
AGZ-15-D	AGZ-15-D-316	150
AGZ-20-D	AGZ-20-D-316	200
AGZ-25-D	AGZ-25-D-316	250
AGZ-30-D	AGZ-30-D-316	300
AGZ-35-D	AGZ-35-D-316	350
AGZ-40-D	AGZ-40-D-316	400
AGZ-45-D	AGZ-45-D-316	450
AGZ-50-D	AGZ-50-D-316	500
AGZ-55-D	AGZ-55-D-316	550
AGZ-60-D	AGZ-60-D-316	600
AGZ-65-D	AGZ-65-D-316	650
AGZ-70-D	AGZ-70-D-316	700
AGZ-75-D	AGZ-75-D-316	750



90° bøjning (H: 30 mm)

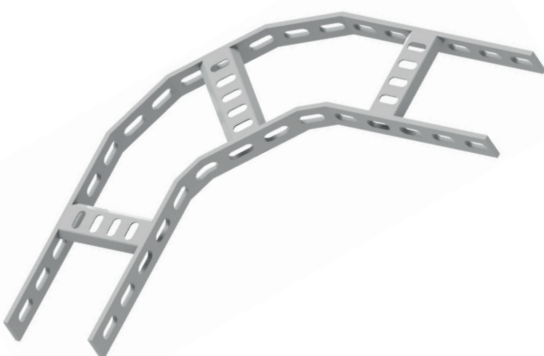

Vare-nr. (HDG)	Vare-nr. (SS316)	Bredde (mm)
AGV-10-D	AGV-10-D-316	100
AGV-15-D	AGV-15-D-316	150
AGV-20-D	AGV-20-D-316	200
AGV-25-D	AGV-25-D-316	250
AGV-30-D	AGV-30-D-316	300
AGV-35-D	AGV-35-D-316	350
AGV-40-D	AGV-40-D-316	400
AGV-45-D	AGV-45-D-316	450
AGV-50-D	AGV-50-D-316	500
AGV-55-D	AGV-55-D-316	550
AGV-60-D	AGV-60-D-316	600

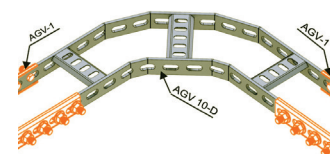

90° vinkelbeslag (H: 40 mm)



Vare-nr. (HDG)	Vare-nr. (SS316)	Bredde (mm)
AGS 10-DE	AGS 10-DE-316	100
AGS 15-DE	AGS 15-DE-316	150
AGS 20-D	AGS 20-D-316	200
AGS 25-D	AGS 25-D-316	250
AGS 30-D	AGS 30-D-316	300
AGS 35-D	AGS 35-D-316	350
AGS 40-D	AGS 40-D-316	400
AGS 45-D	AGS 45-D-316	450
AGS 50-D	AGS 50-D-316	500
AGS 55-D	AGS 55-D-316	550
AGS 60-D	AGS 60-D-316	600
AGS 65-D	AGS 65-D-316	650
AGS 70-D	AGS 70-D-316	700
AGS 75-D	AGS 75-D-316	750

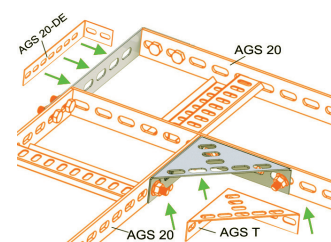

90° vinkelbeslag (H: 37 mm)

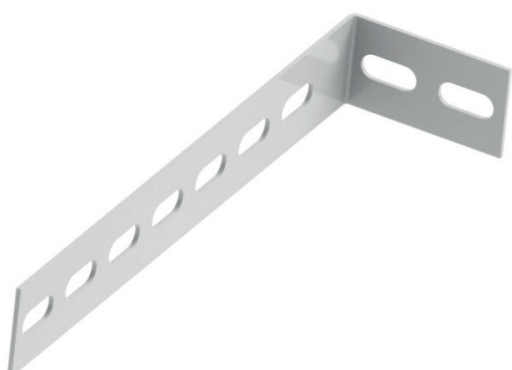

Vare-nr. (HDG)	Vare-nr. (SS316)	Bredde (mm)
AGZ-10-DE	AGZ-10-DE-316	100
AGZ-15-DE	AGZ-15-DE-316	150
AGZ-20-D	AGZ-20-D-316	200
AGZ-25-D	AGZ-25-D-316	250
AGZ-30-D	AGZ-30-D-316	300
AGZ-35-D	AGZ-35-D-316	350
AGZ-40-D	AGZ-40-D-316	400
AGZ-45-D	AGZ-45-D-316	450
AGZ-50-D	AGZ-50-D-316	500
AGZ-55-D	AGZ-55-D-316	550
AGZ-60-D	AGZ-60-D-316	600
AGZ-65-D	AGZ-65-D-316	650
AGZ-70-D	AGZ-70-D-316	700
AGZ-75-D	AGZ-75-D-316	750

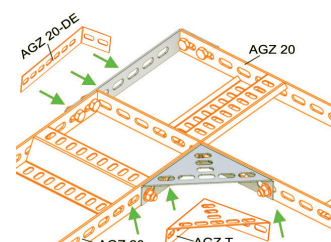

90° vinkelbeslag (H: 30 mm)



Vare-nr. (HDG)	Vare-nr. (SS316)	Bredde (mm)
AGV-10-DE	AGV-10-DE-316	100
AGV-15-DE	AGV-15-DE-316	150
AGV-20-D	AGV-20-D-316	200
AGV-25-D	AGV-25-D-316	250
AGV-30-D	AGV-30-D-316	300
AGV-35-D	AGV-35-D-316	350
AGV-40-D	AGV-40-D-316	400
AGV-45-D	AGV-45-D-316	450
AGV-50-D	AGV-50-D-316	500
AGV-55-D	AGV-55-D-316	550
AGV-60-D	AGV-60-D-316	600
AGV-65-D	AGV-65-D-316	650
AGV-70-D	AGV-70-D-316	700
AGV-75-D	AGV-75-D-316	750

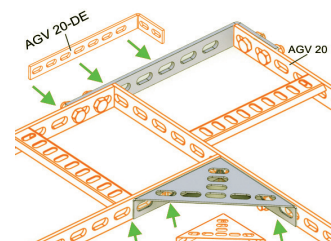

90° bøjning (H: 40 mm)



Vare-nr. (HDG)	Vare-nr. (SS316)	Bredde (mm)
AGS-10-DI	AGS-10-DI-316	100
AGS-15-DI	AGS-15-DI-316	150
AGS-20-DI	AGS-20-DI-316	200
AGS-25-DI	AGS-25-DI-316	250
AGS-30-DI	AGS-30-DI-316	300
AGS-35-DI	AGS-35-DI-316	350
AGS-40-DI	AGS-40-DI-316	400
AGS-45-DI	AGS-45-DI-316	450
AGS-50-DI	AGS-50-DI-316	500
AGS-55-DI	AGS-55-DI-316	550
AGS-60-DI	AGS-60-DI-316	600
AGS-65-DI	AGS-65-DI-316	650
AGS-70-DI	AGS-70-DI-316	700
AGS-75-DI	AGS-75-DI-316	750

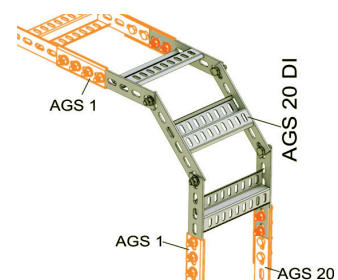

90° bøjning (H: 37 mm)



Vare-nr. (HDG)	Vare-nr. (SS316)	Bredde (mm)
AGZ-10-DI	AGZ-10-DI-316	100
AGZ-15-DI	AGZ-15-DI-316	150
AGZ-20-DI	AGZ-20-DI-316	200
AGZ-25-DI	AGZ-25-DI-316	250
AGZ-30-DI	AGZ-30-DI-316	300
AGZ-35-DI	AGZ-35-DI-316	350
AGZ-40-DI	AGZ-40-DI-316	400
AGZ-45-DI	AGZ-45-DI-316	450
AGZ-50-DI	AGZ-50-DI-316	500
AGZ-55-DI	AGZ-55-DI-316	550
AGZ-60-DI	AGZ-60-DI-316	600
AGZ-65-DI	AGZ-65-DI-316	650
AGZ-70-DI	AGZ-70-DI-316	700
AGZ-75-DI	AGZ-75-DI-316	750

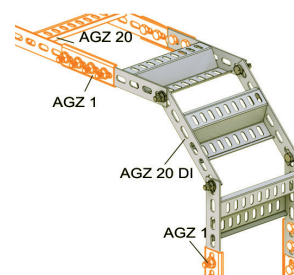

90° bøjning (H: 30 mm)



Vare-nr. (HDG)	Vare-nr. (SS316)	Bredde (mm)
AGV-10-DI	AGV-10-DI-316	100
AGV-15-DI	AGV-15-DI-316	150
AGV-20-DI	AGV-20-DI-316	200
AGV-25-DI	AGV-25-DI-316	250
AGV-30-DI	AGV-30-DI-316	300
AGV-35-DI	AGV-35-DI-316	350
AGV-40-DI	AGV-40-DI-316	400
AGV-45-DI	AGV-45-DI-316	450
AGV-50-DI	AGV-50-DI-316	500
AGV-55-DI	AGV-55-DI-316	550
AGV-60-DI	AGV-60-DI-316	600

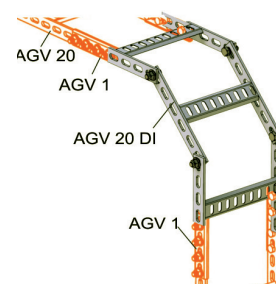

T- & KRYDSSTYKKER

T- & krydsstykke (H: 40 mm)

Vare-nr. (HDG)	Vare-nr. (SS316)	Bredde (mm)
AGS-T	AGS-T-316	140

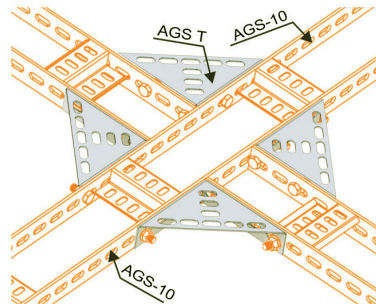
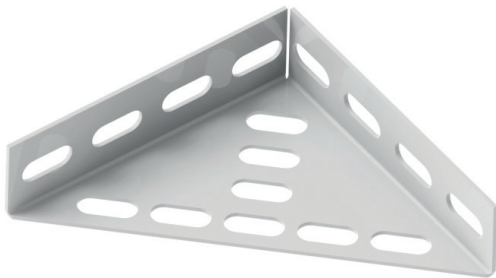

Kryds

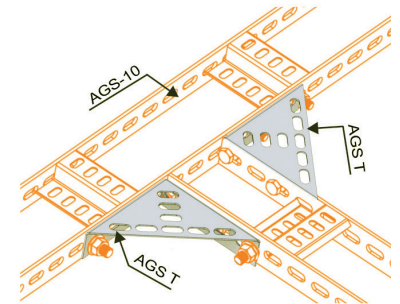

T

T- & krydsstykke (H: 37 mm)

Vare-nr. (HDG)	Vare-nr. (SS316)	Bredde (mm)
AGZ-T	AGZ-T-316	140

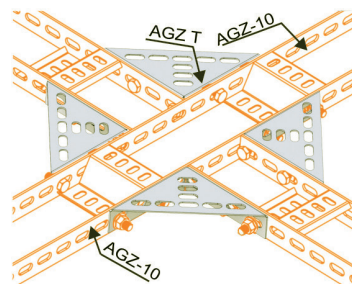
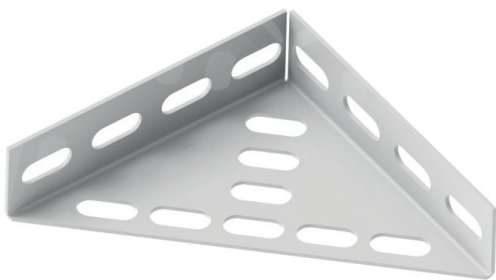

Kryds

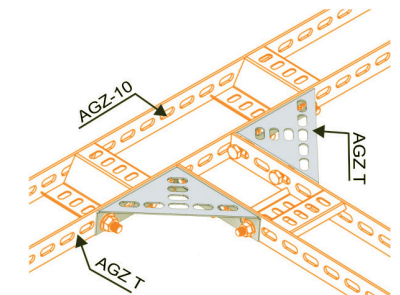

T

T- & krydsstykke (H: 30 mm)

Vare-nr. (HDG)	Vare-nr. (SS316)	Bredde (mm)
AGV-T	AGV-T-316	140

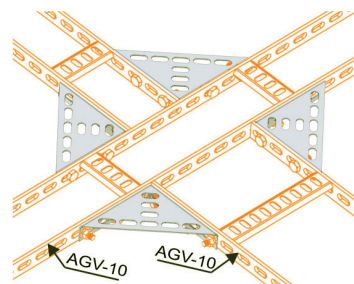
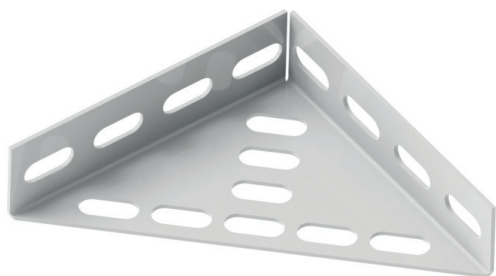

Kryds

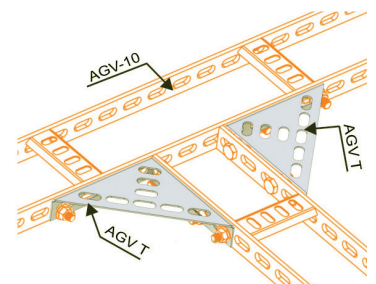

T

TILBEHØR

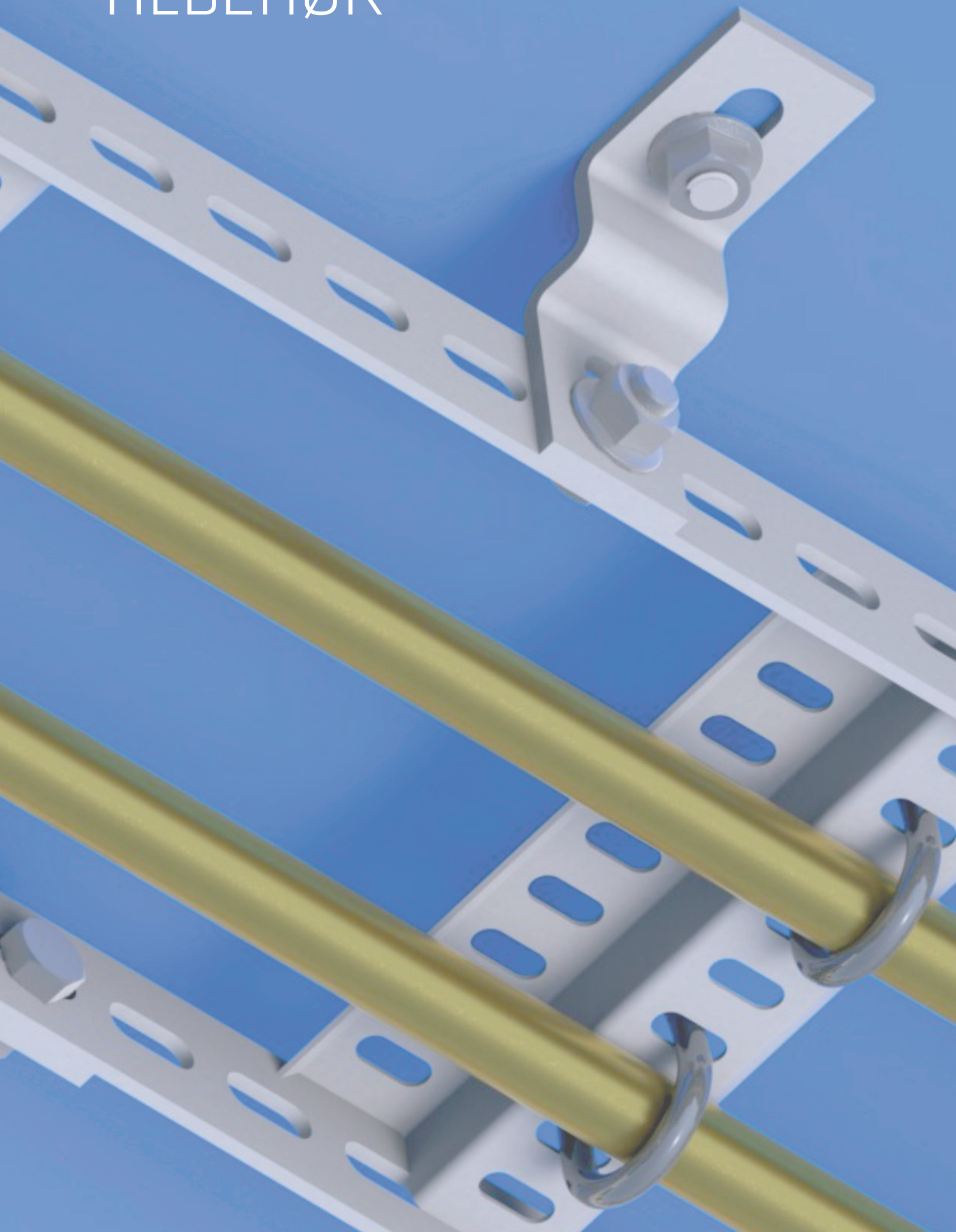

Vægbeslag #1

Vare-nr. (HDG)	Vare-nr. (SS316)	Længde (mm)
AI-H-SC	AI-H-SC-316	55

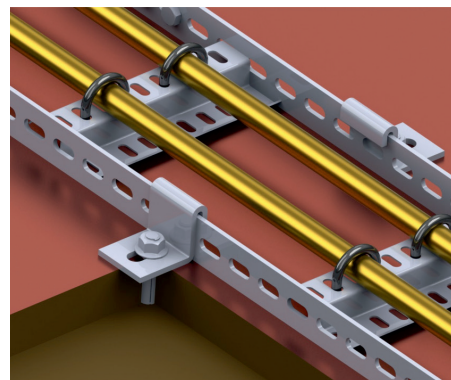
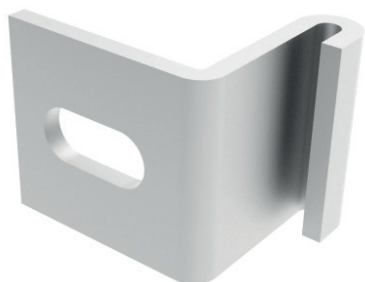

Vægbeslag #2 & #3

Vare-nr. (HDG)	Vare-nr. (SS316)	Længde (mm)
A5-6-40	A5-6-40-316	40
A5-6-60	A5-6-60-316	60

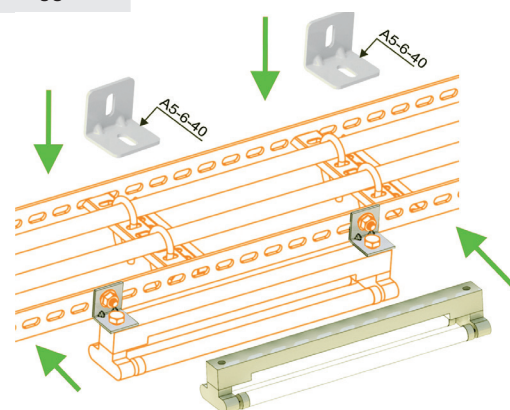

Vægbeslag #4

Vare-nr. (HDG)	Vare-nr. (SS316)
AI-DP-2	AI-DP-2-316

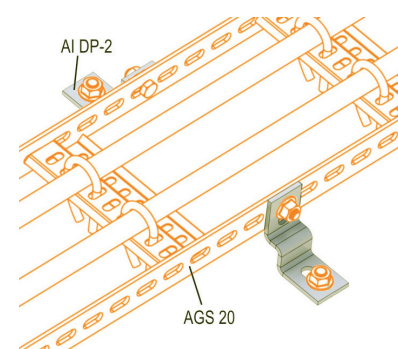
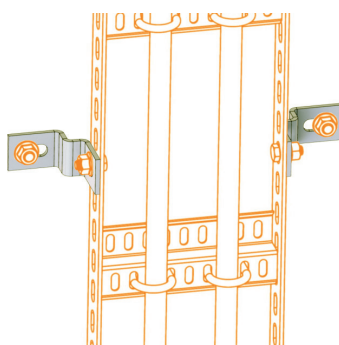
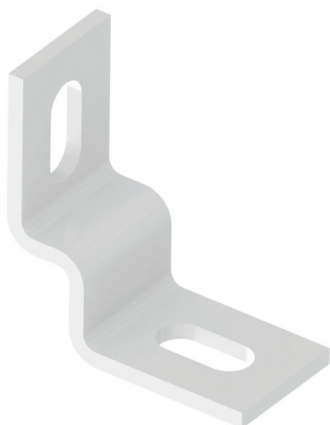

KONTAKTINFORMATION

Michael Steenberg

Salgskonsulent, Marine
Tlf.: 2069 7204
mst@scankab.dk

Jan Christensen

Produktansvarlig, Føringsveje
Tlf.: 6343 1545
jc@scankabsystems.dk



Michael Steenberg

Jan Christensen

Morten Skougaard

Anne Lehd Jepsen

Morten Skougaard

Kundesupport, Kabler
Tlf.: 6343 1538
ms@scankab.dk

Anne Lehd Jepsen

Kundesupport, Føringsveje
Tlf.: 6343 1542
aj@scankabsystems.dk

Scankab Systems A/S

Malervænget 3
5560 Aarup
Tlf.: 6343 1545